



 • Zubehörband siehe Falzband



KANADA-SCHINDEL

Al-Legierung, inkl. Befestigung, ab 25° Dachneigung. Bedarf: 9,8 Stk./m², Gewicht: 2,76 kg/m²



Anthrazit Pearls
(ähnl. RAL 7016)

Hausgrau Pearls
(ähnl. DB703)

Rot Pearls
(ähnl. RAL 3009)



GRÖSSE

445 x 230 mm

KANADA-SCHINDEL SMOOTH

Al-Legierung, inkl. Befestigung, ab 25° Dachneigung. Bedarf: 9,8 Stk./m², Gewicht: 2,76 kg/m²



Anthrazit Pearls
(ähnl. RAL 7016)

Hausgrau Pearls
(ähnl. DB703)

Rot Pearls
(ähnl. RAL 3009)



GRÖSSE

445 x 230 mm



QUADRAT-SCHINDEL

Al-Legierung, inkl. Befestigung. Weitere Größen und Farben auf Anfrage, ab 25° Dachneigung.



GRÖSSE
330 x 330 mm
Bedarf: 9,18 Stk./m ² , Gewicht: 2,76 kg/m ²
410 x 410 mm
Bedarf: 5,9 Stk./m ² , Gewicht: 2,54 kg/m ²
510 x 510 mm
Bedarf: 3,85 Stk./m ² , Gewicht: 2,40 kg/m ²

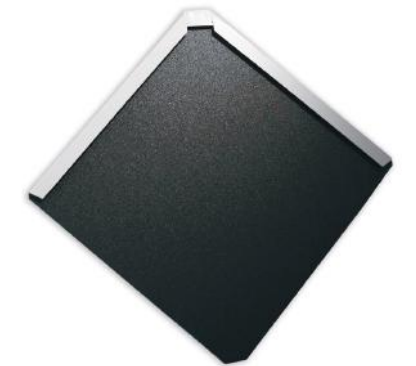



3D SCHNITT

FIRST-/ GRATAUSBILDUNG BELÜFTET

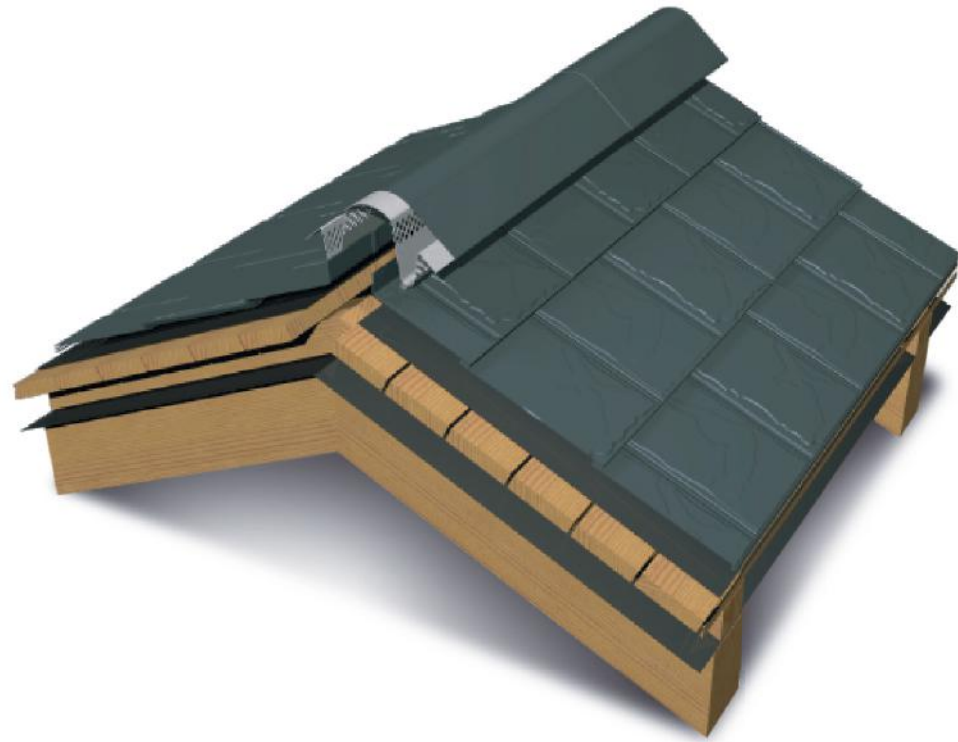

3D SCHNITT

FIRST-/ GRATAUSBILDUNG UNBELÜFTET

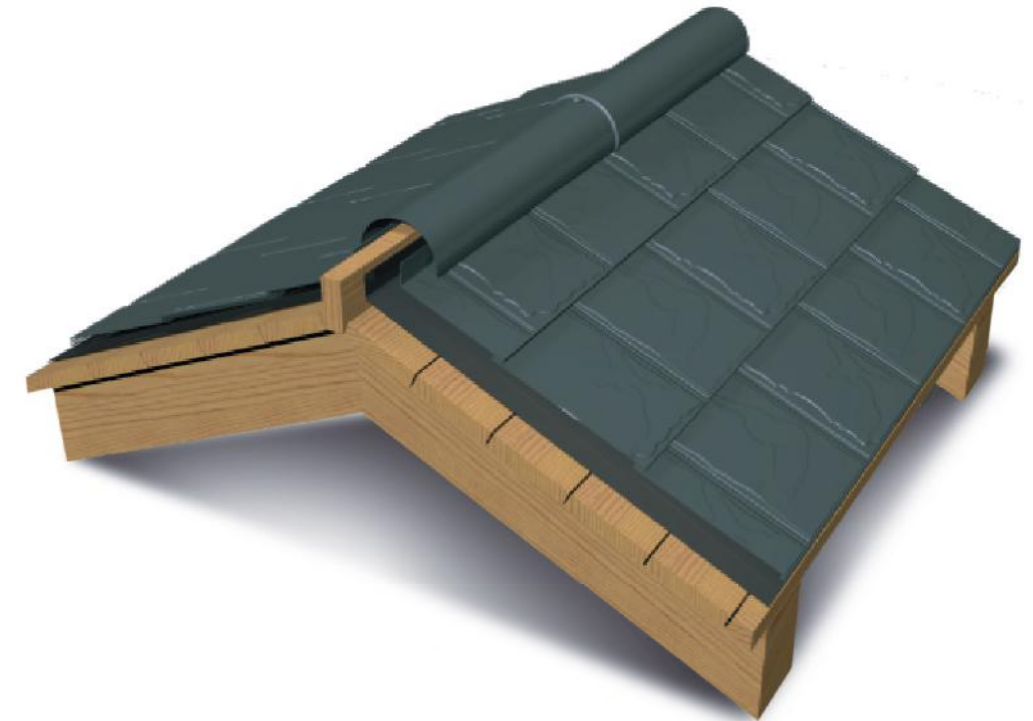

DETAIL FIRST-/ GRATAUSBILDUNG BELÜFTET

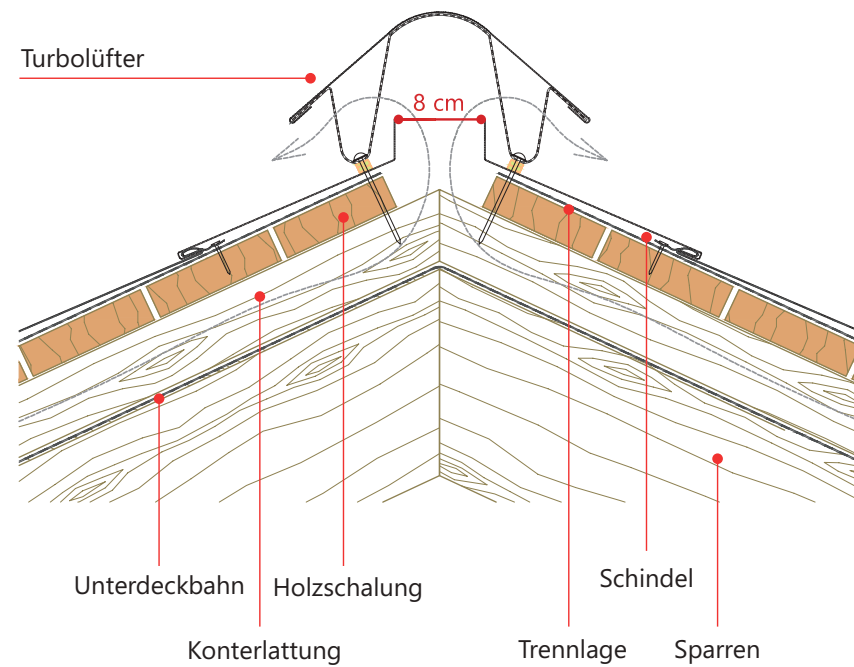

DETAIL FIRST-/ GRATAUSBILDUNG UNBELÜFTET

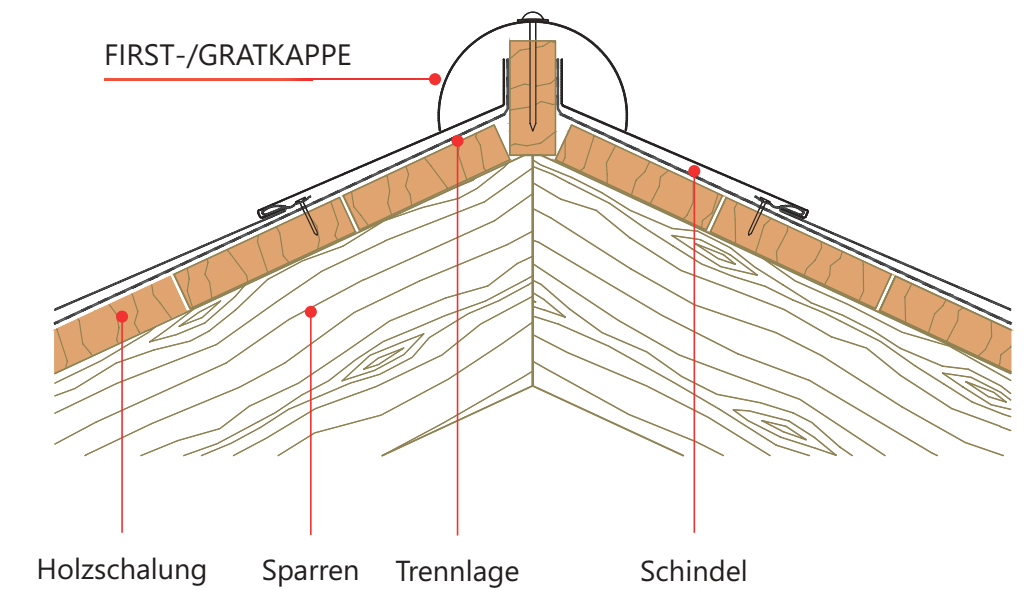



3D SCHNITT

PULTDACHABSCHLUSS HINTERLÜFTET

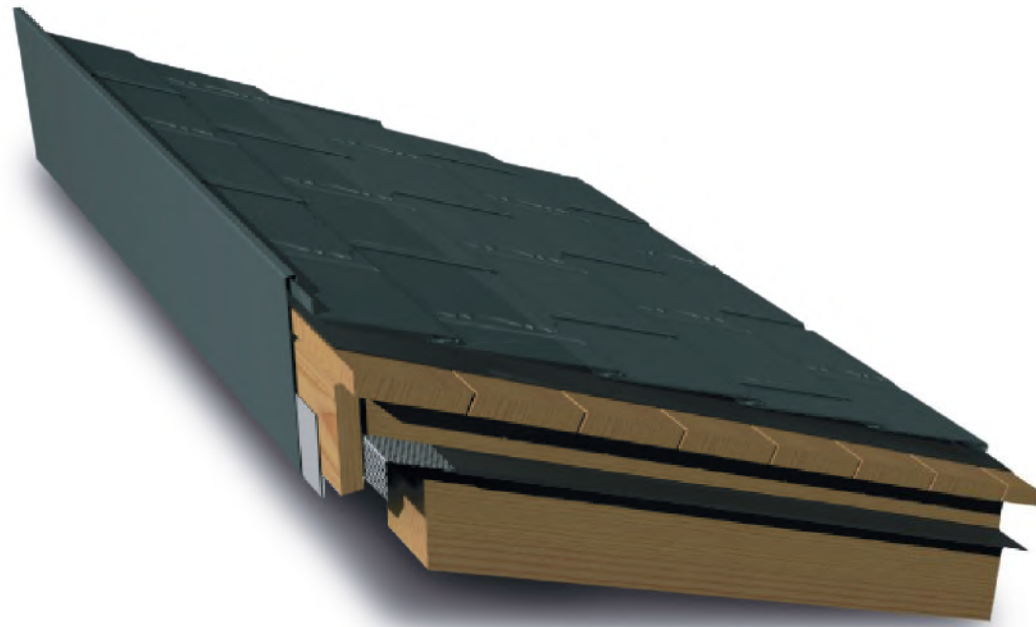

3D SCHNITT

TRAUFENAUSBILDUNG



DETAIL PULTDACHABSCHLUSS HINTERLÜFTET

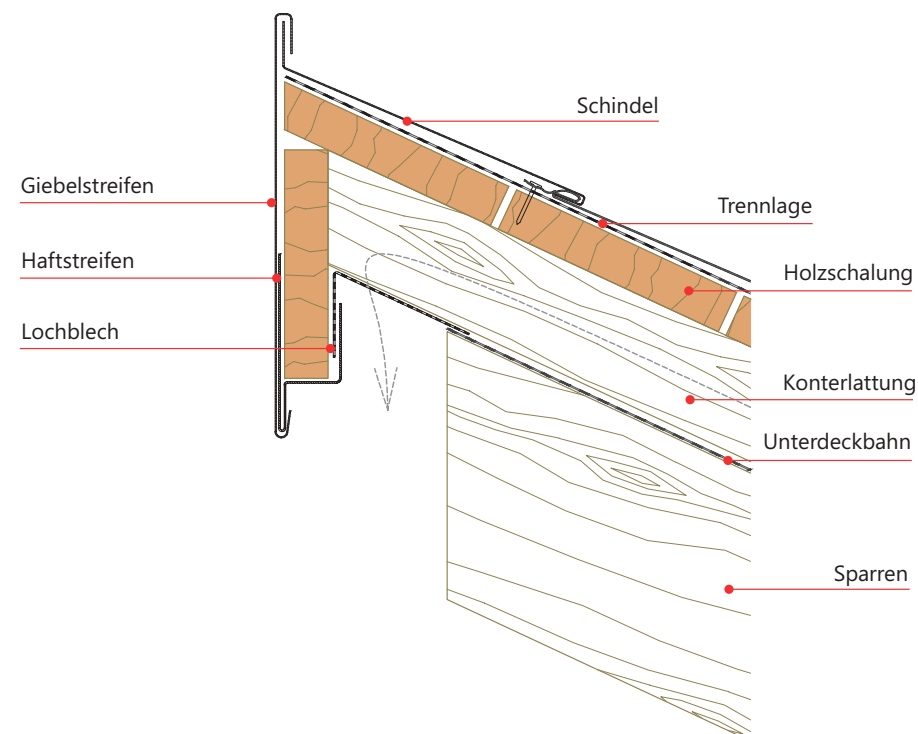

DETAIL TRAUFENAUSBILDUNG

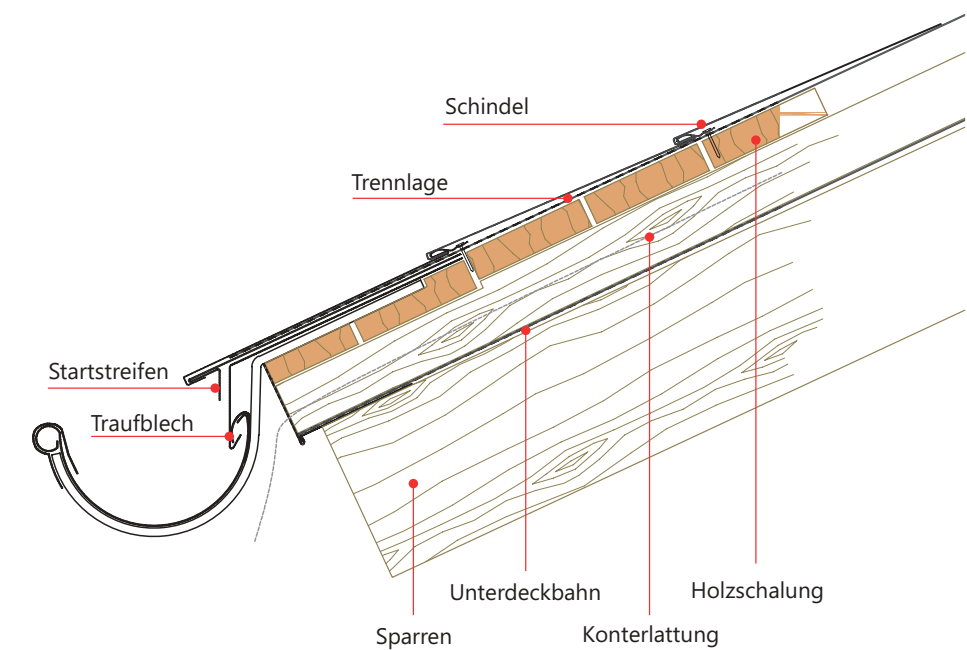



3D SCHNITT

ORTGANGAUSBILDUNG VARIANTE 1



3D SCHNITT

ORTGANGAUSBILDUNG VARIANTE 2

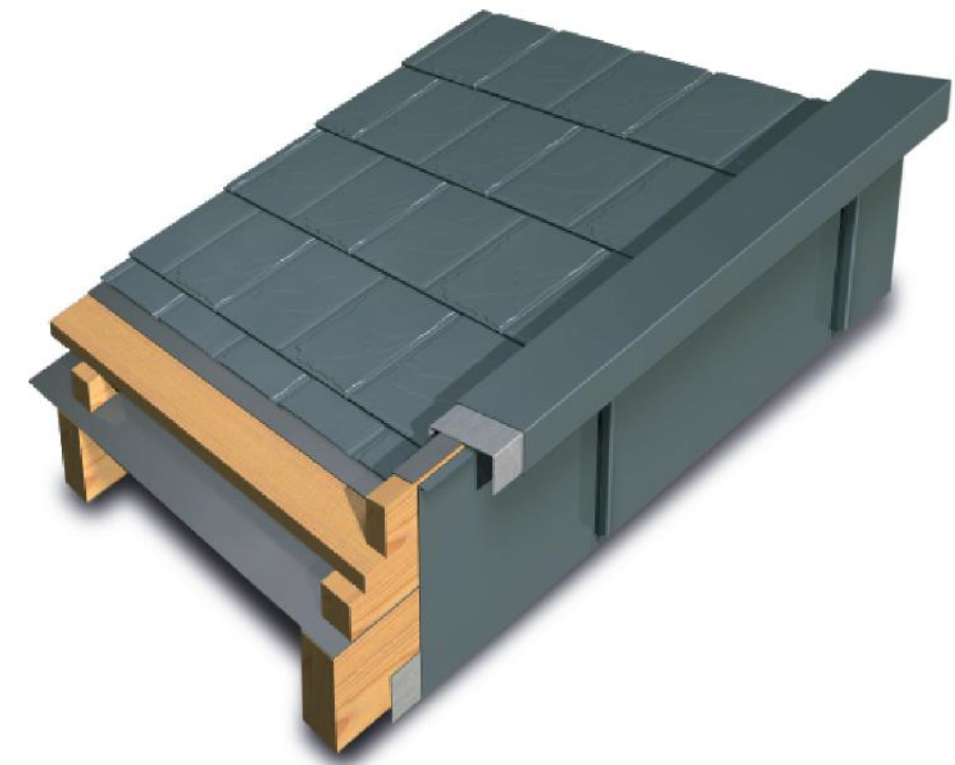

DETAIL ORTGANGAUSBILDUNG VARIANTE 1

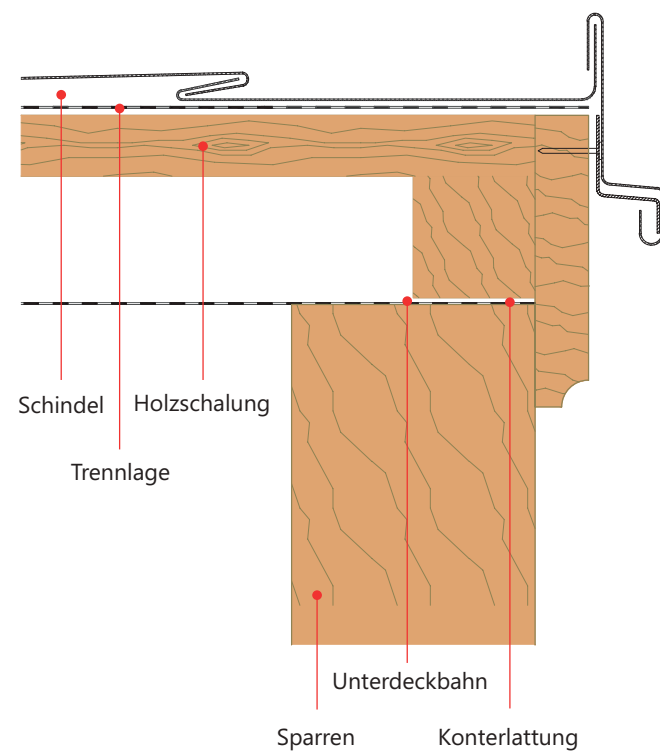

DETAIL ORTGANGAUSBILDUNG VARIANTE 2

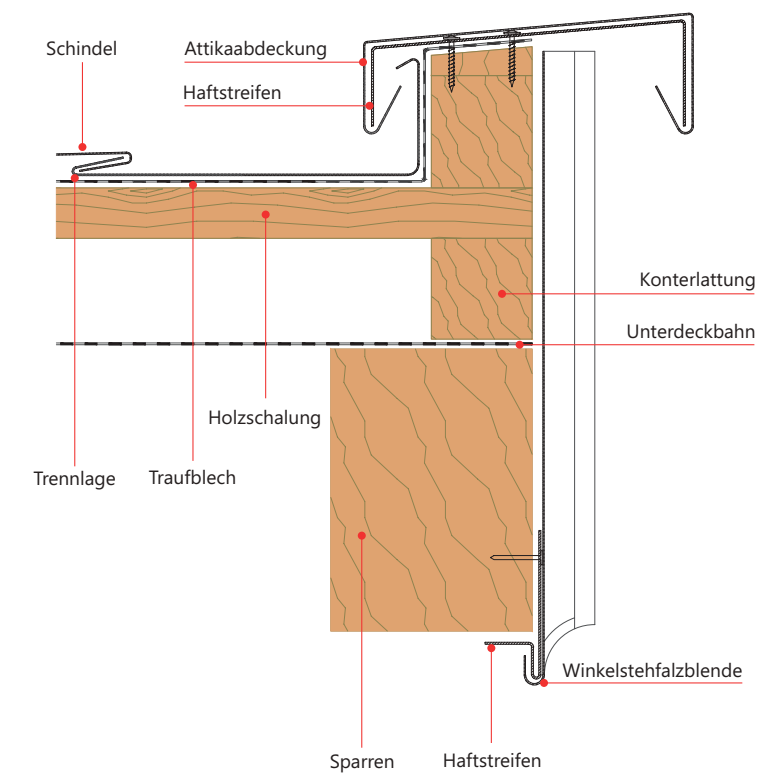



3D SCHNITT

SEITLICHER WANDANSCHLUSS MIT KAPPLEISTE

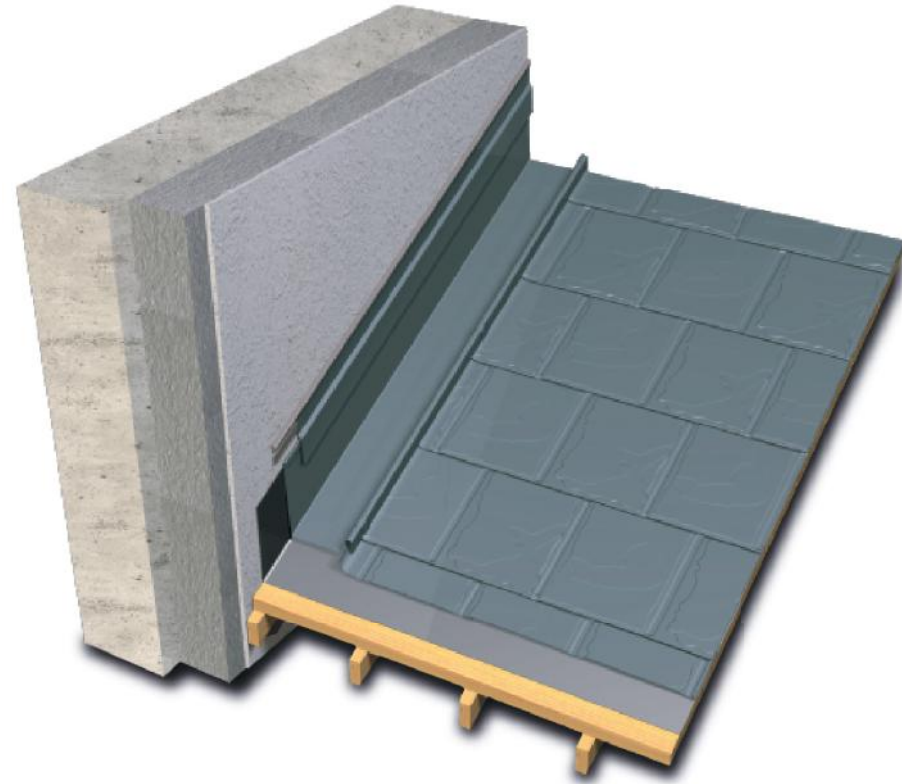

3D SCHNITT

SEITLICHER WANDANSCHLUSS MIT BLECHANSCHLUSSPROFIL

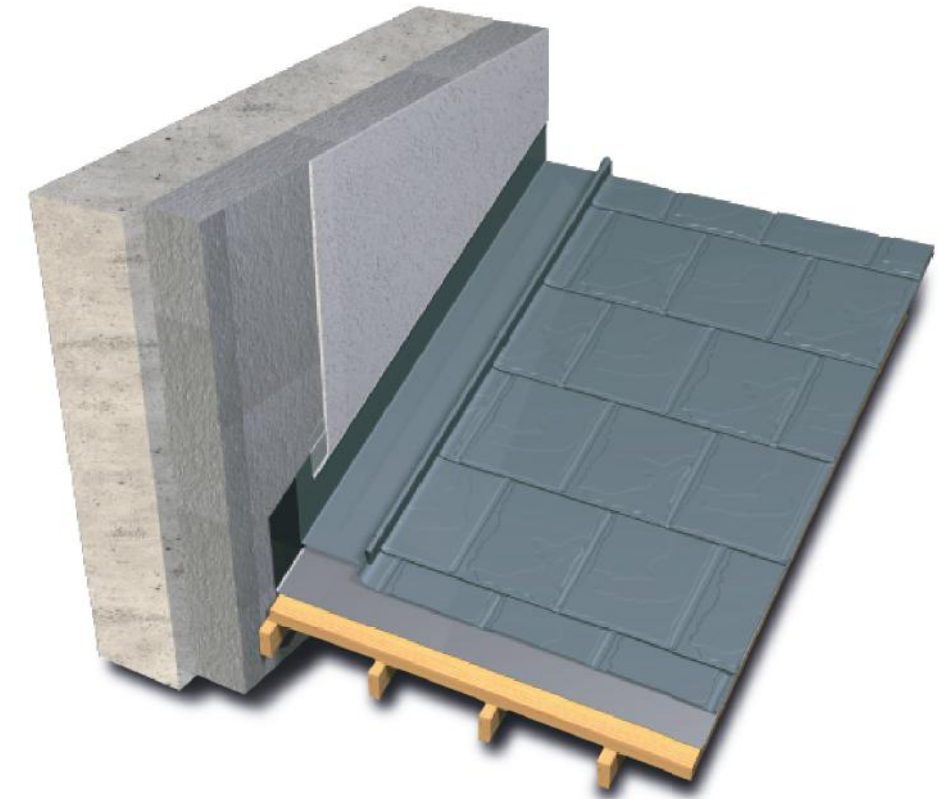

DETAIL SEITLICHER WANDANSCHLUSS MIT KAPPLEISTE

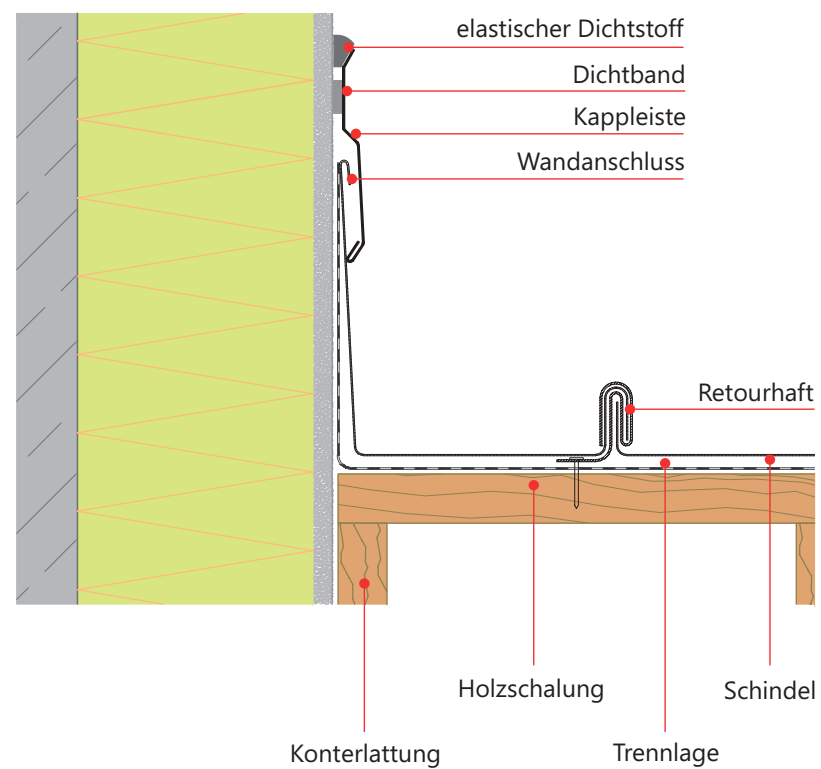

DETAIL SEITLICHER WANDANSCHLUSS MIT BLECHANSCHLUSSPROFIL

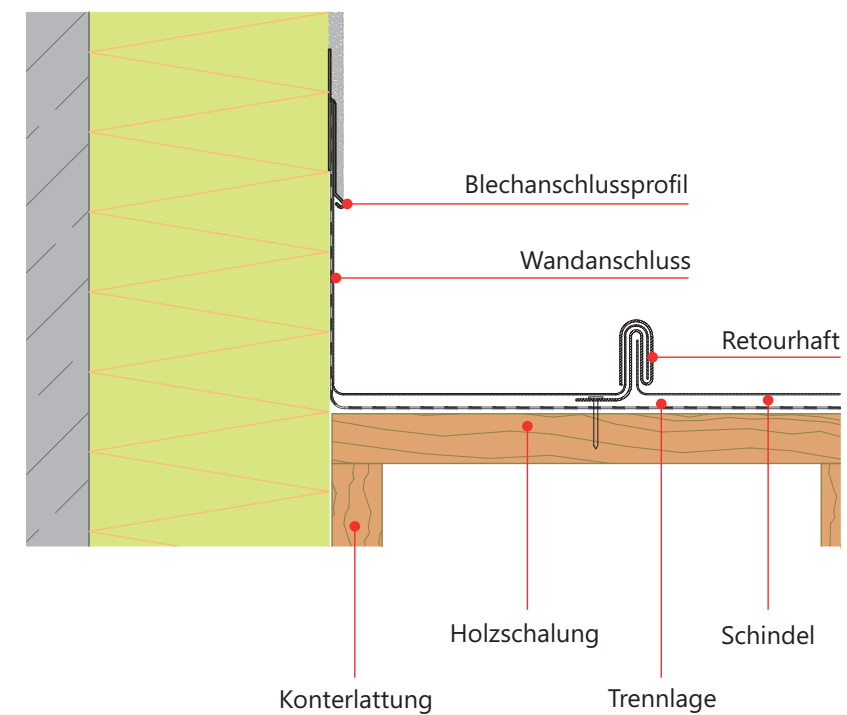

ANSCHLUSSHÖHEN			
Dachneigung	S	T	F
Anschluss	in mm		
< 5°	150	150	150
< 22°	100	100	150
≤ 22°	80 ¹⁾	80	150

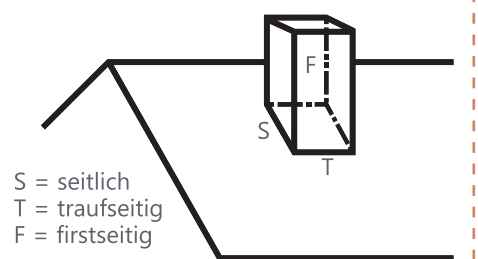

¹⁾ Bei abgetreppten Anschlüssen beträgt S über Deckungswerkstoff mindestens 65mm. Gemessen werden diese Anschluss Höhen rechtwinklig zur wasserführenden Ebene.



3D SCHNITT

SEITLICHER WANDANSCHLUSS MIT KITTPUTZLEISTE

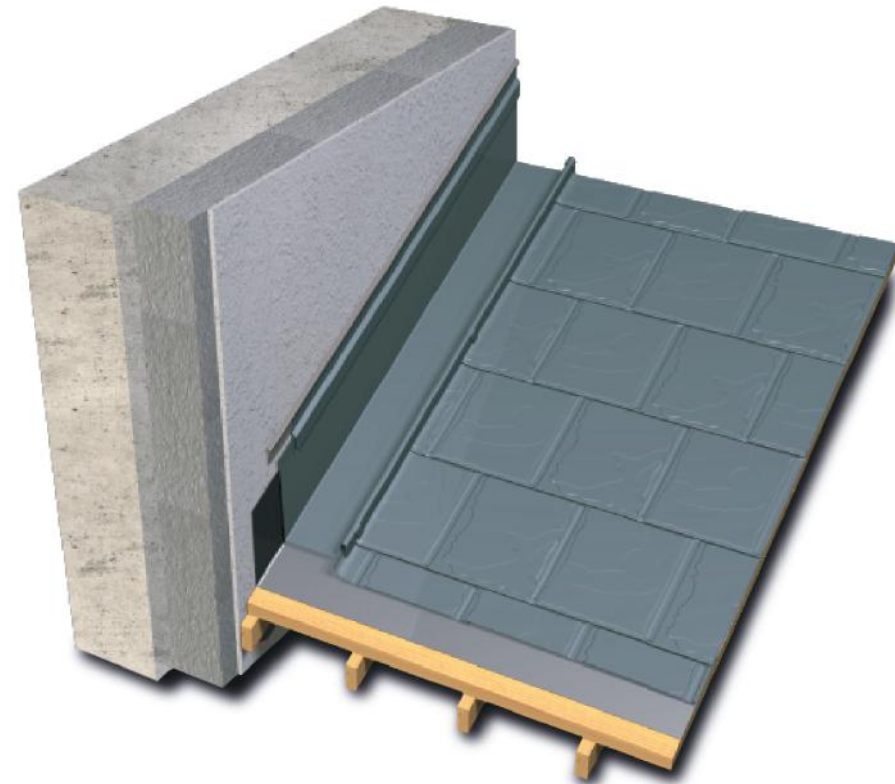

3D SCHNITT

SCHNITT VERTIEFTE KEHLE VARIANTE 1

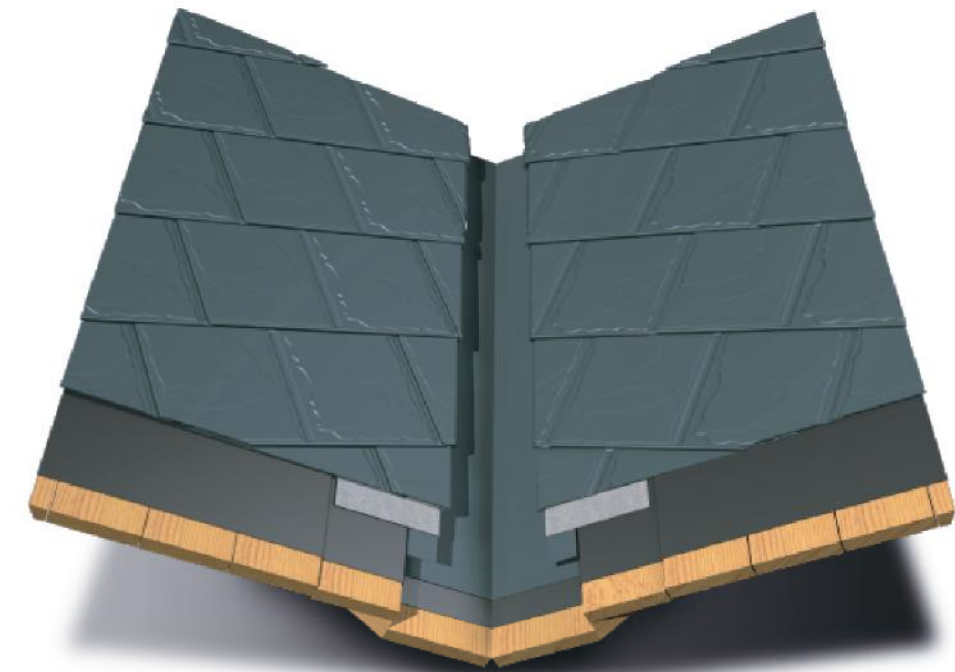

DETAIL SEITLICHER WANDANSCHLUSS MIT KITTPUTZLEISTE

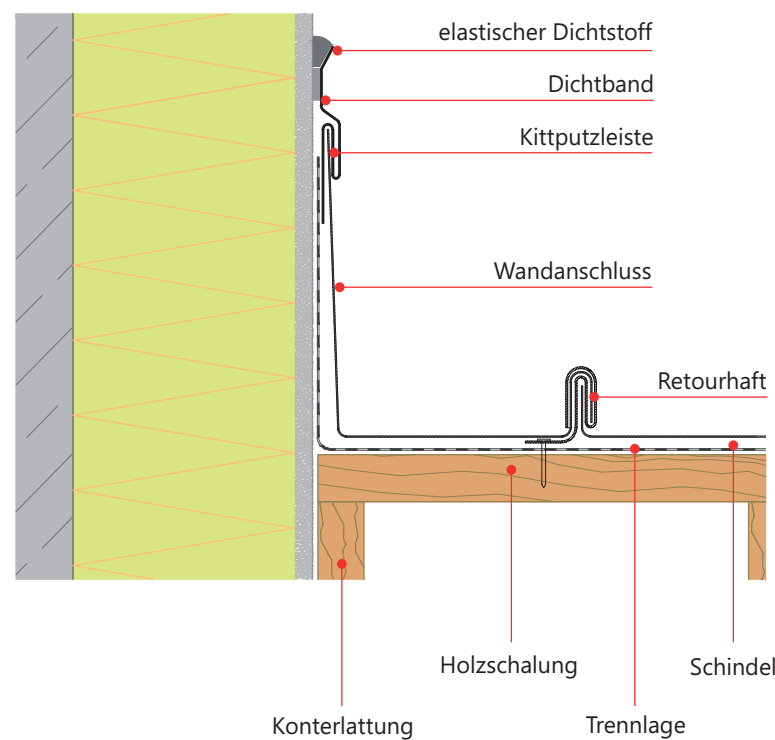

ANSCHLUSSHÖHEN

Dachneigung Anschluss	S	T	F
	in mm		
< 5°	150	150	150
< 22°	100	100	150
≤ 22°	80 ¹⁾	80	150

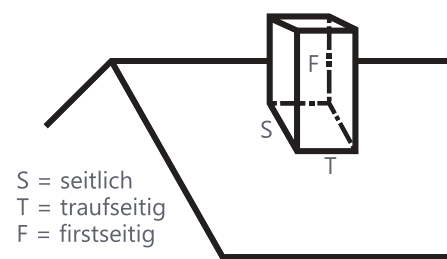

S = seitlich
T = traufseitig
F = firstseitig

¹⁾ Bei abgetreppten Anschlüssen beträgt S über Deckungswerkstoff mindestens 65mm. Gemessen werden diese Anschluss Höhen rechtwinklig zur wasserführenden Ebene.

DETAIL VERTIEFTE KEHLE

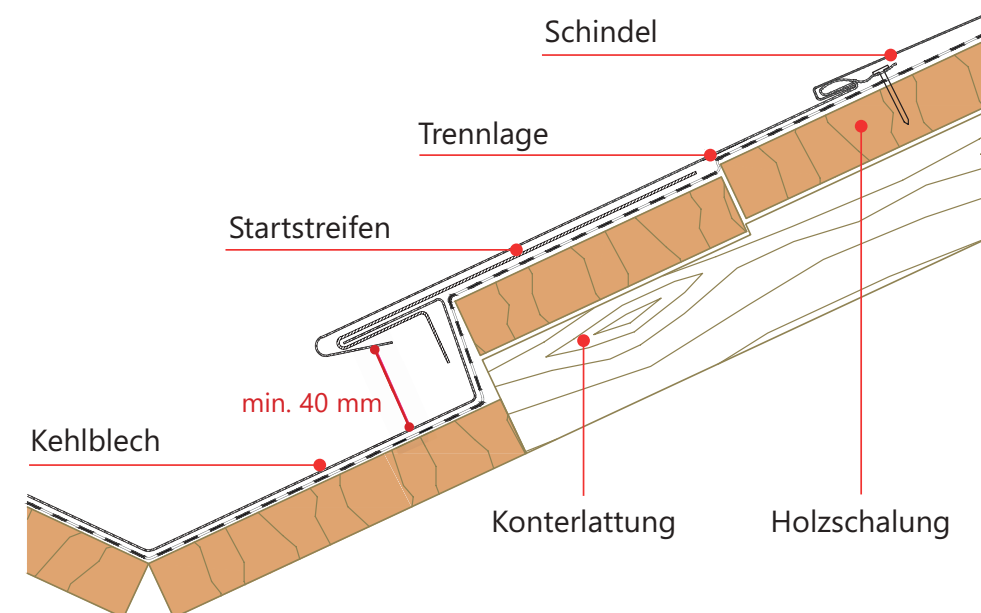



3D SCHNITT
VERTIEFTE KEHLE VARIANTE 2

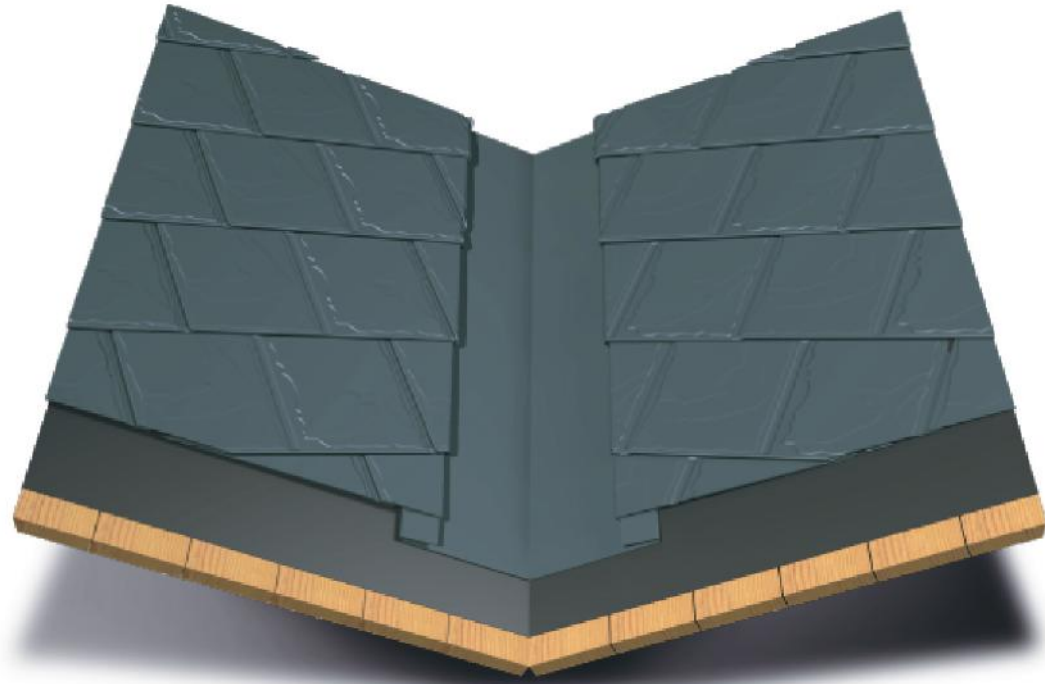

3D SCHNITT
MANSARDENKNICK

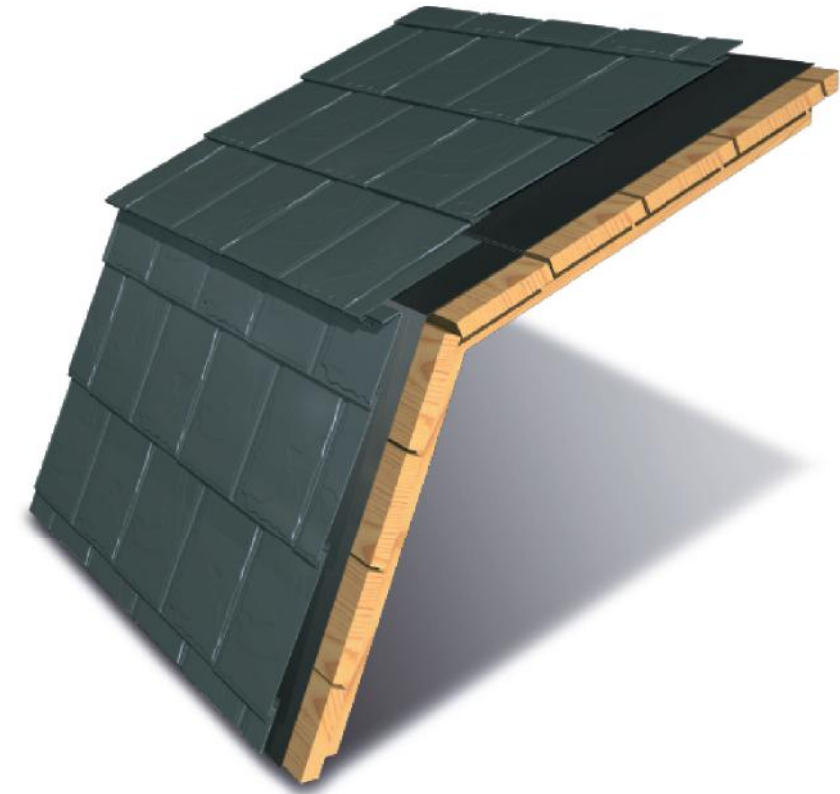

DETAIL KEHLE

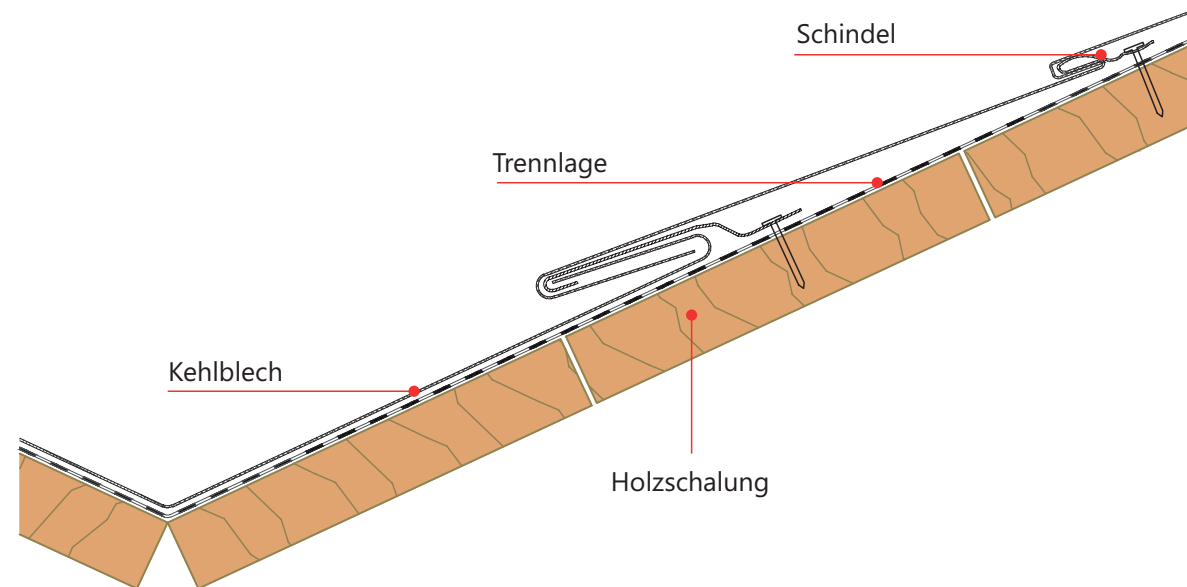

DETAIL MANSARDENKNICK

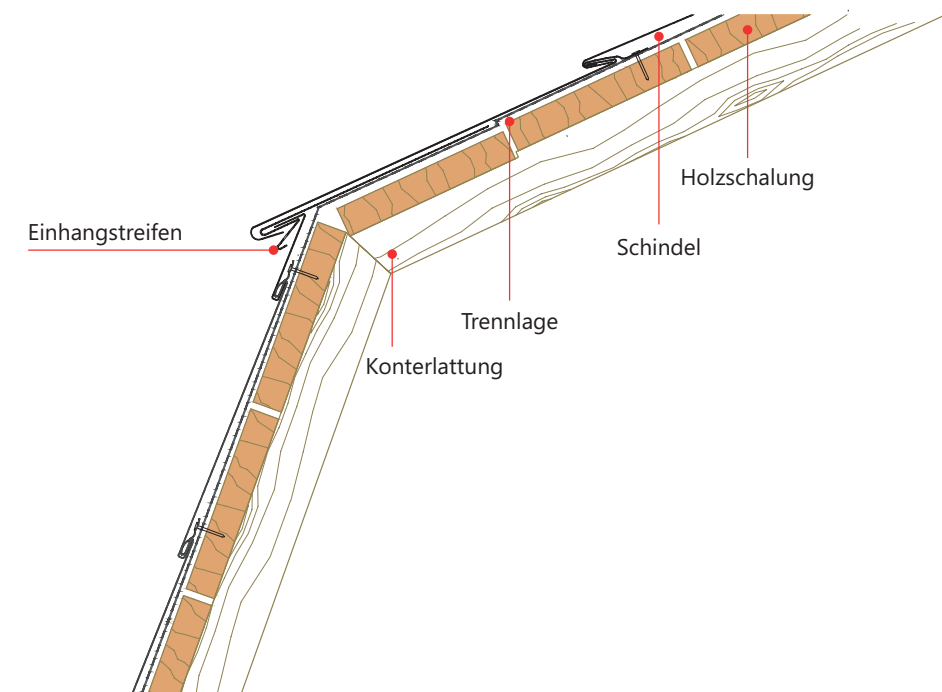



3D SCHNITT
DACHÜBERGANG IN STEHFALZEINDECKUNG



3D SCHNITT
DUNSTROHR

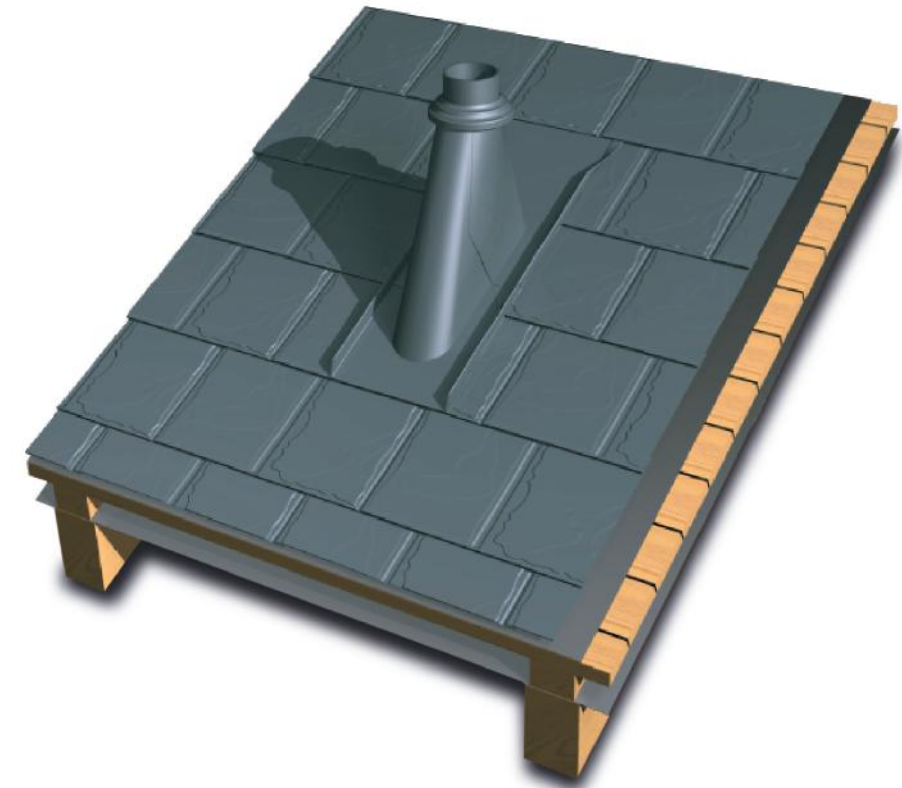

DETAIL DACHÜBERGANG IN STEHFALZEINDECKUNG

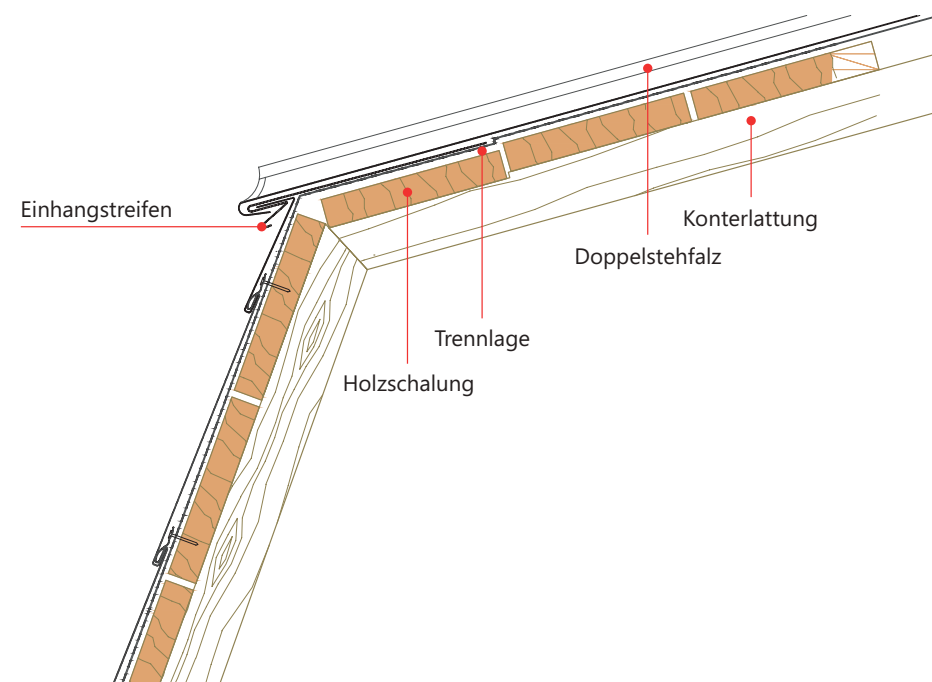

DETAIL DUNSTROHR

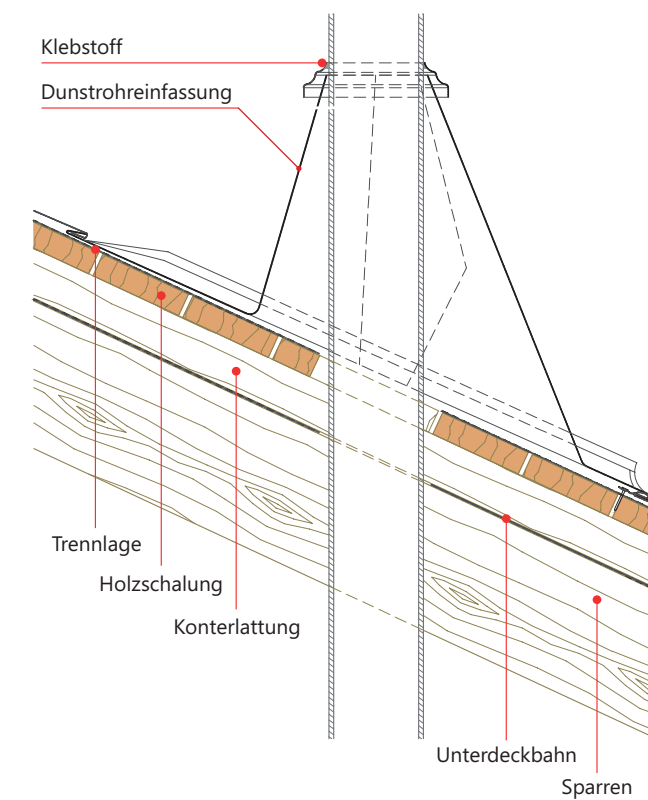



3D SCHNITT

TURBOHAUBE



3D SCHNITT

DACHSICHERHEITSHAKEN



DETAIL TURBOHAUBE

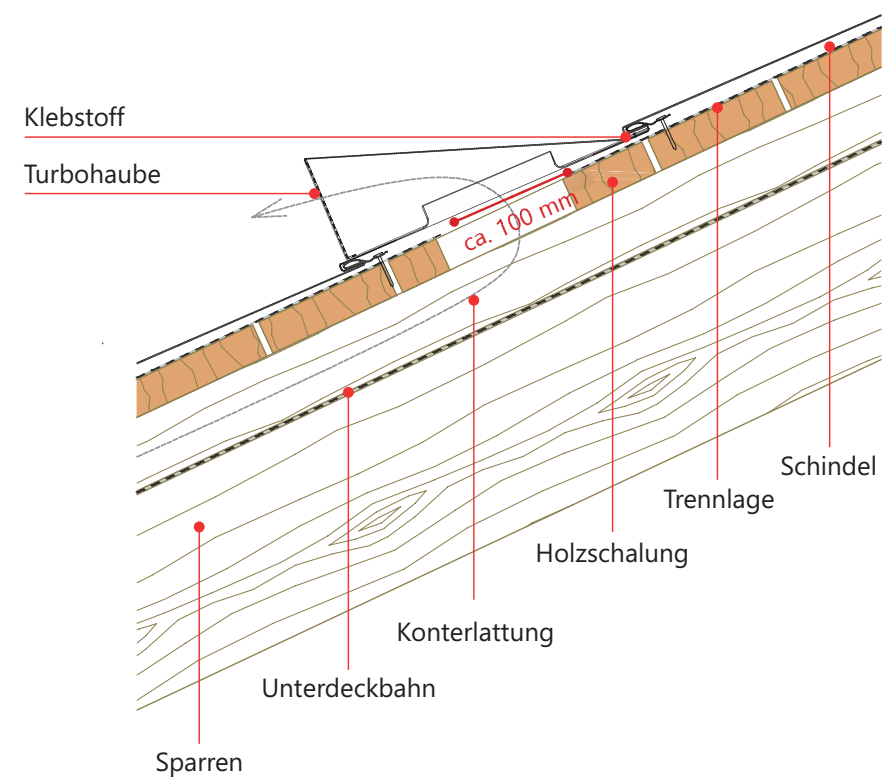

DETAIL DACHSICHERHEITSHAKEN

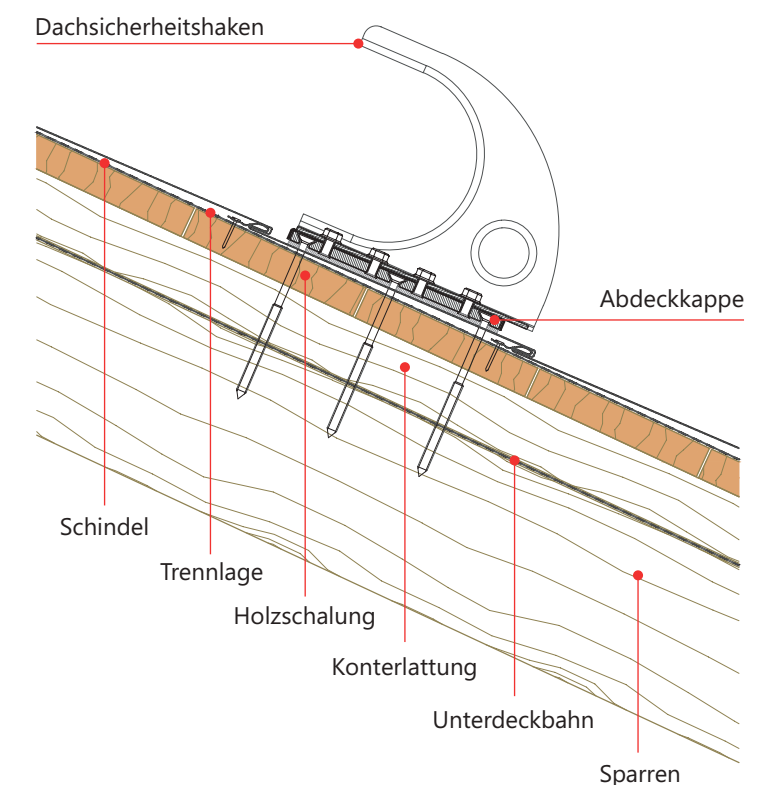



3D SCHNITT
LAUFROST



3D SCHNITT
SCHNEEFANG

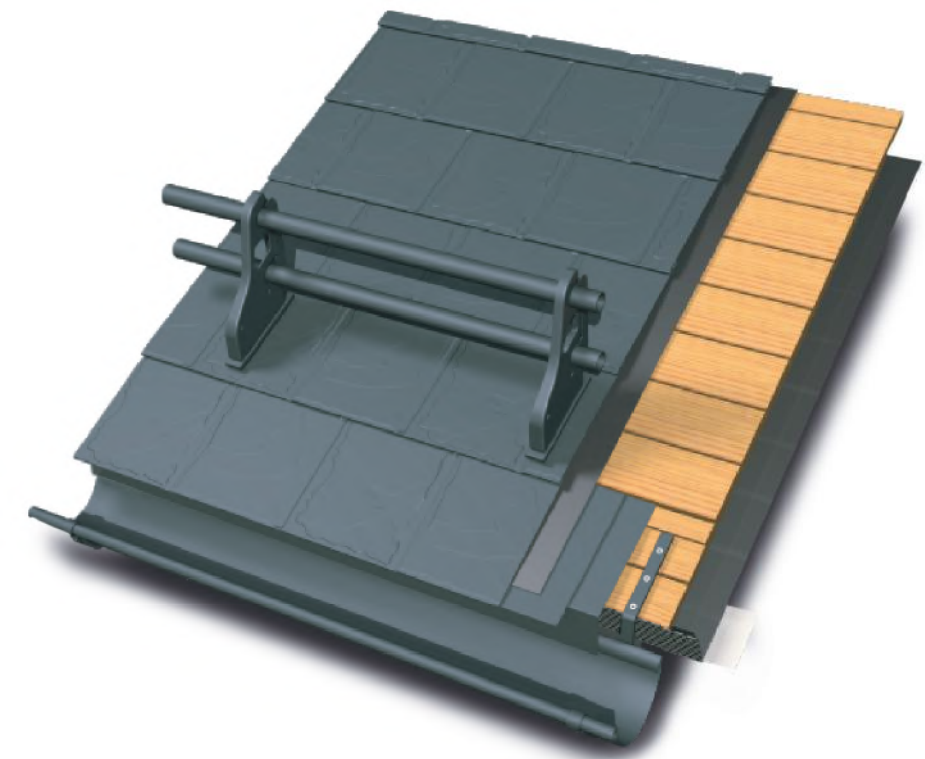

DETAIL LAUFROST

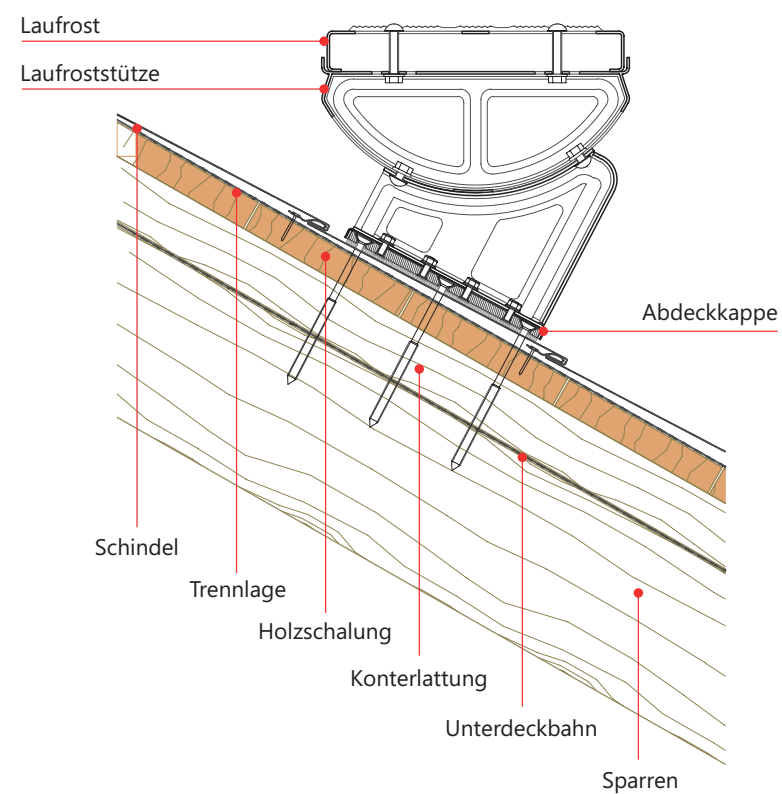

DETAIL SCHNEEFANG

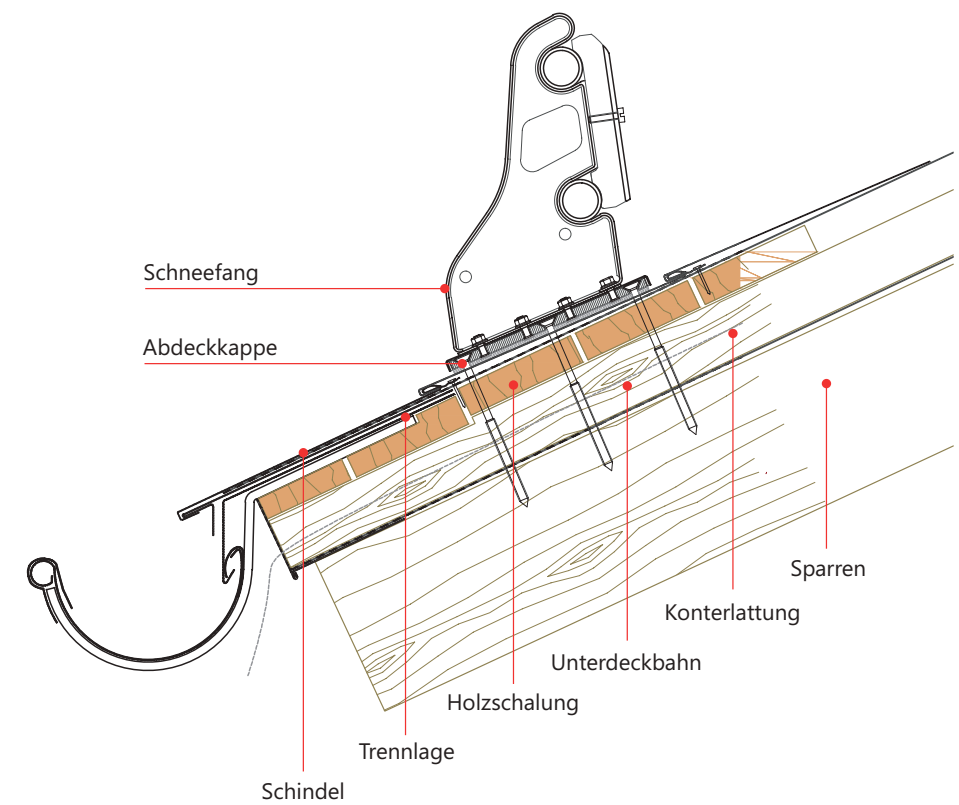



ALU-DACHZIEGEL

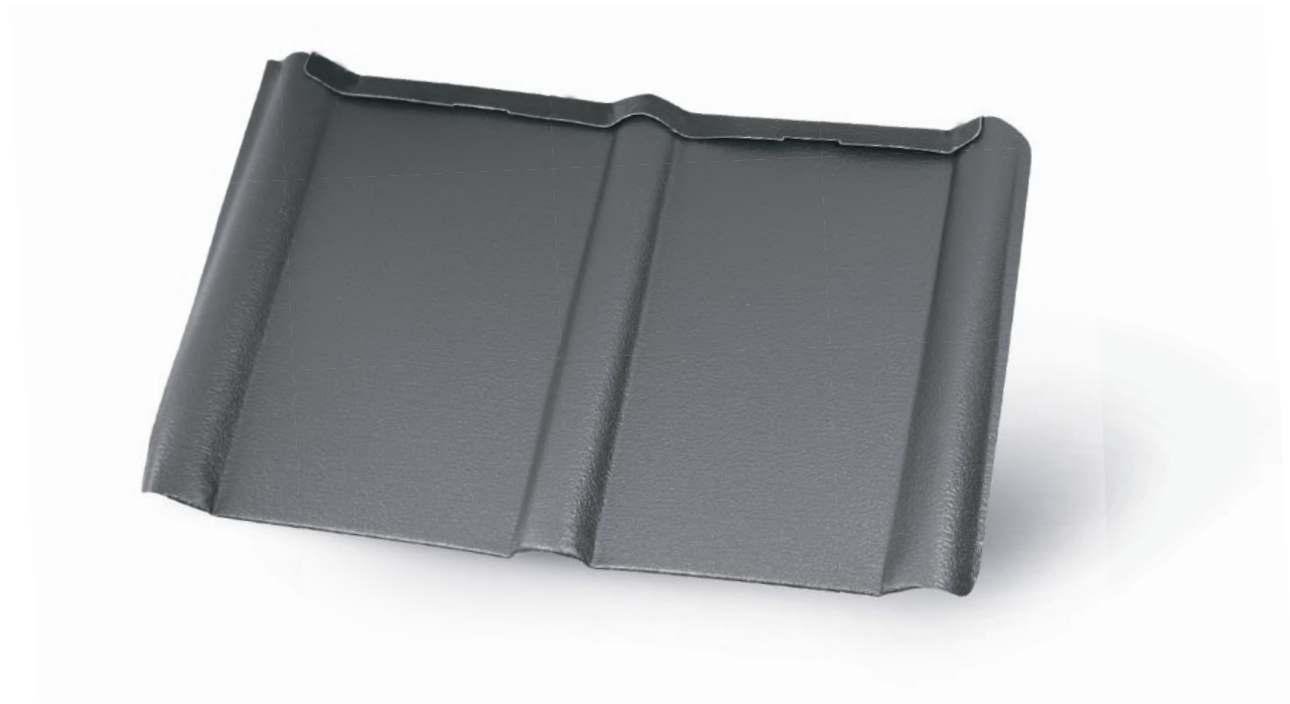

Ab 12° Dachneigung inkl. Befestigung
Passendes Zubehörband erhältlich
Auf Anfrage auch mit Schallschutzstreifen erhältlich (abweichende Lieferzeit)
Bedarf: 4,02 Stk./m², Gewicht: 2,83 kg/m²



GRÖSSE
590 x 422 x 0,7mm

Anthrazit Pearls (ähnl. RAL 7016)	Hausgrau Pearls (ähnl. DB703)
--------------------------------------	----------------------------------

ZUBEHÖR ALU-DACHZIEGEL STARRY

STARTSTREIFEN	SCHNEESTOPPER
für Alu-Dachziegel, Größe 1770 x150 x 1 mm	für Alu-Dachziegel
	



DETAILANSICHT
VERLEGUNG

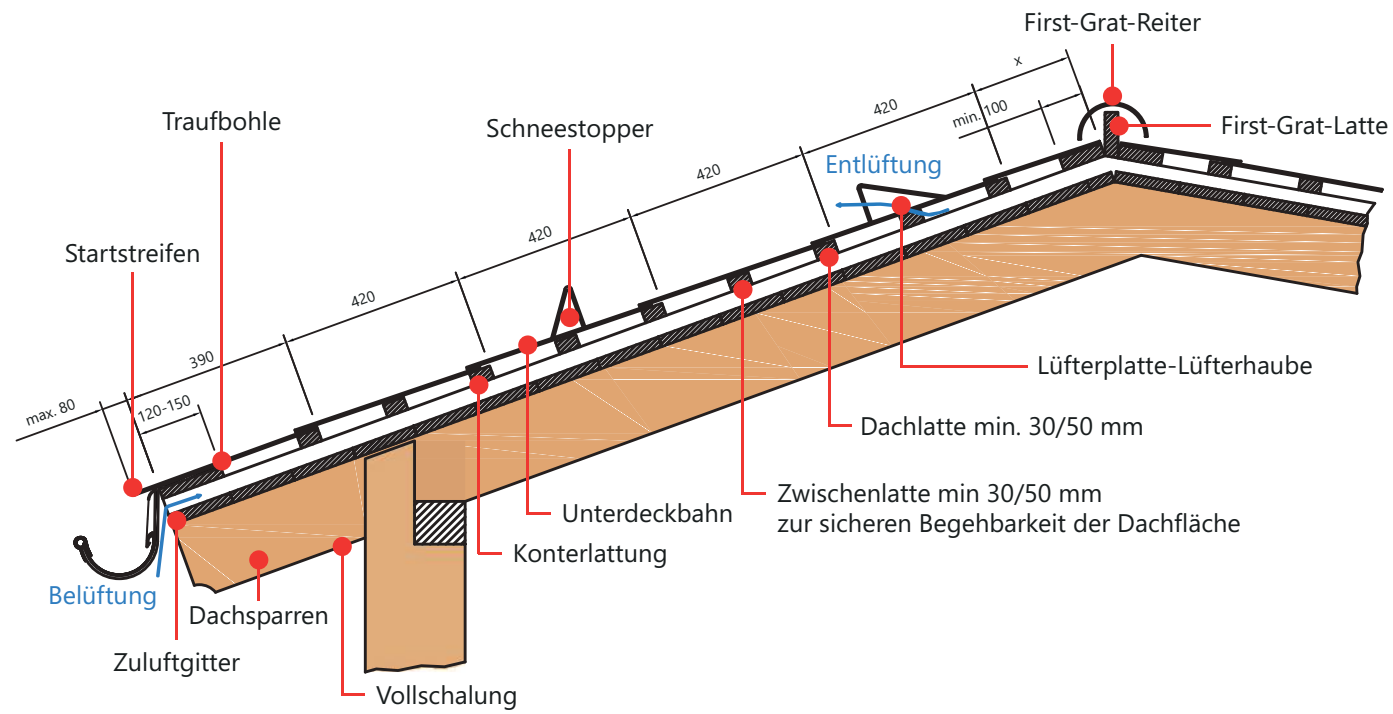

3D SCHNITT
KEHLE



VERLEGERICHTUNG UND -BEFESTIGUNG

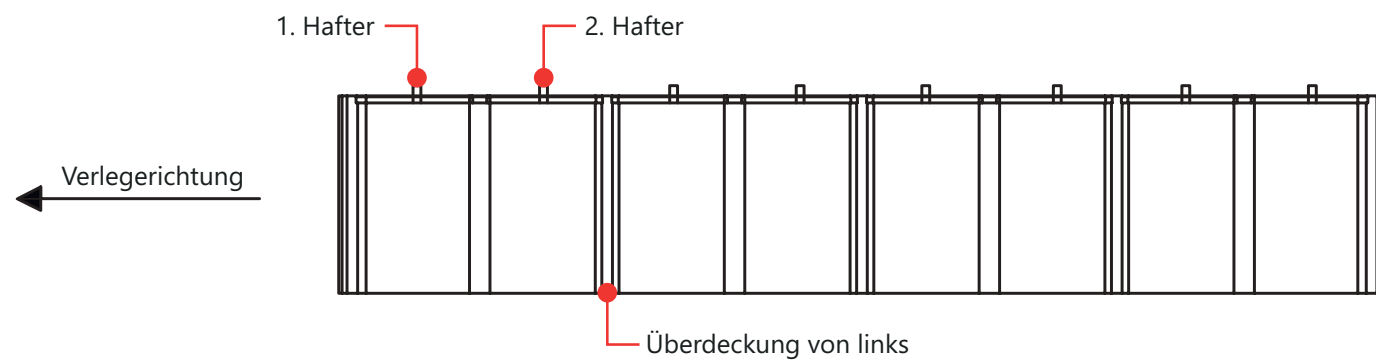

DETAIL KEHLE

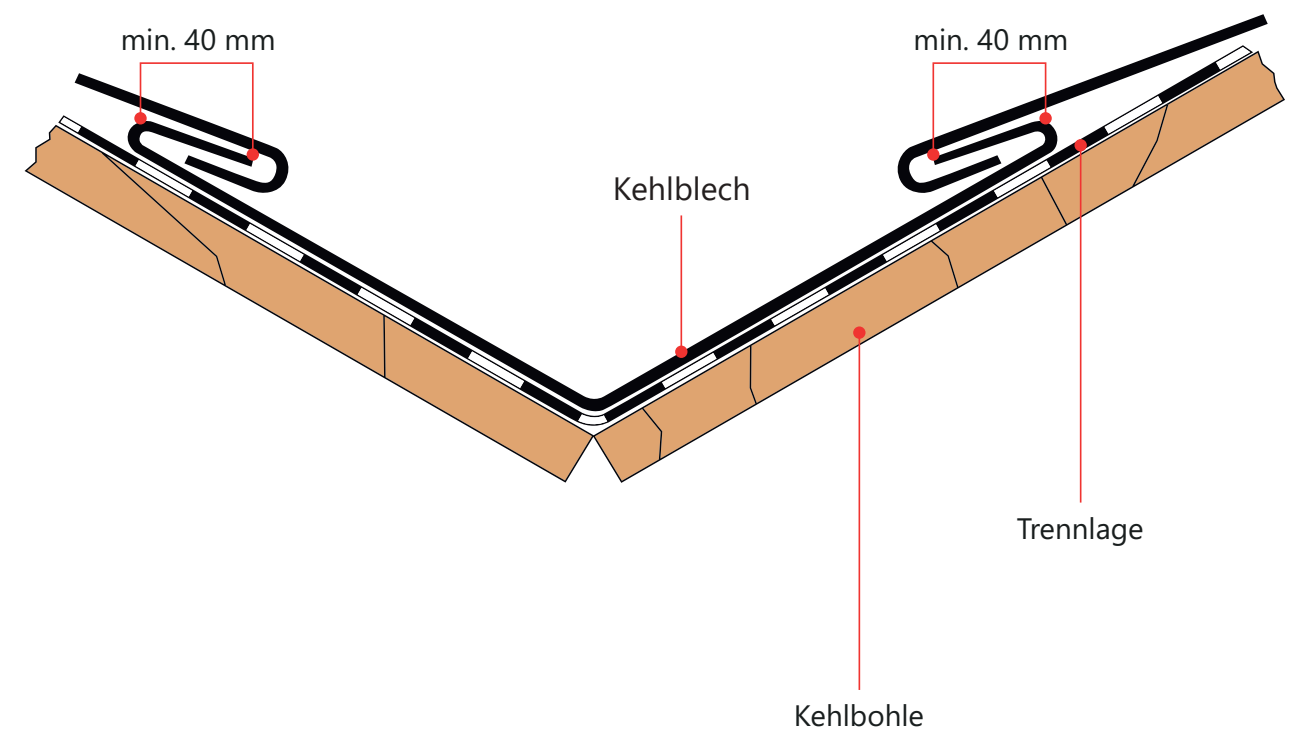



TRAUFDetail

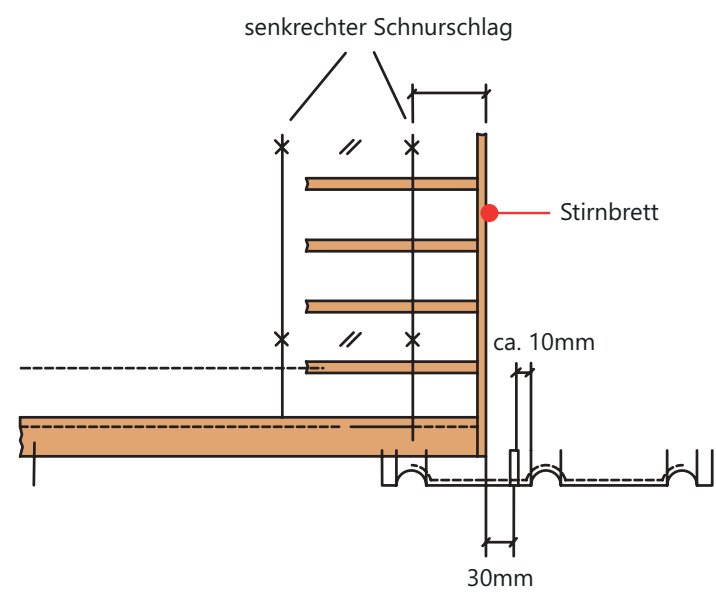
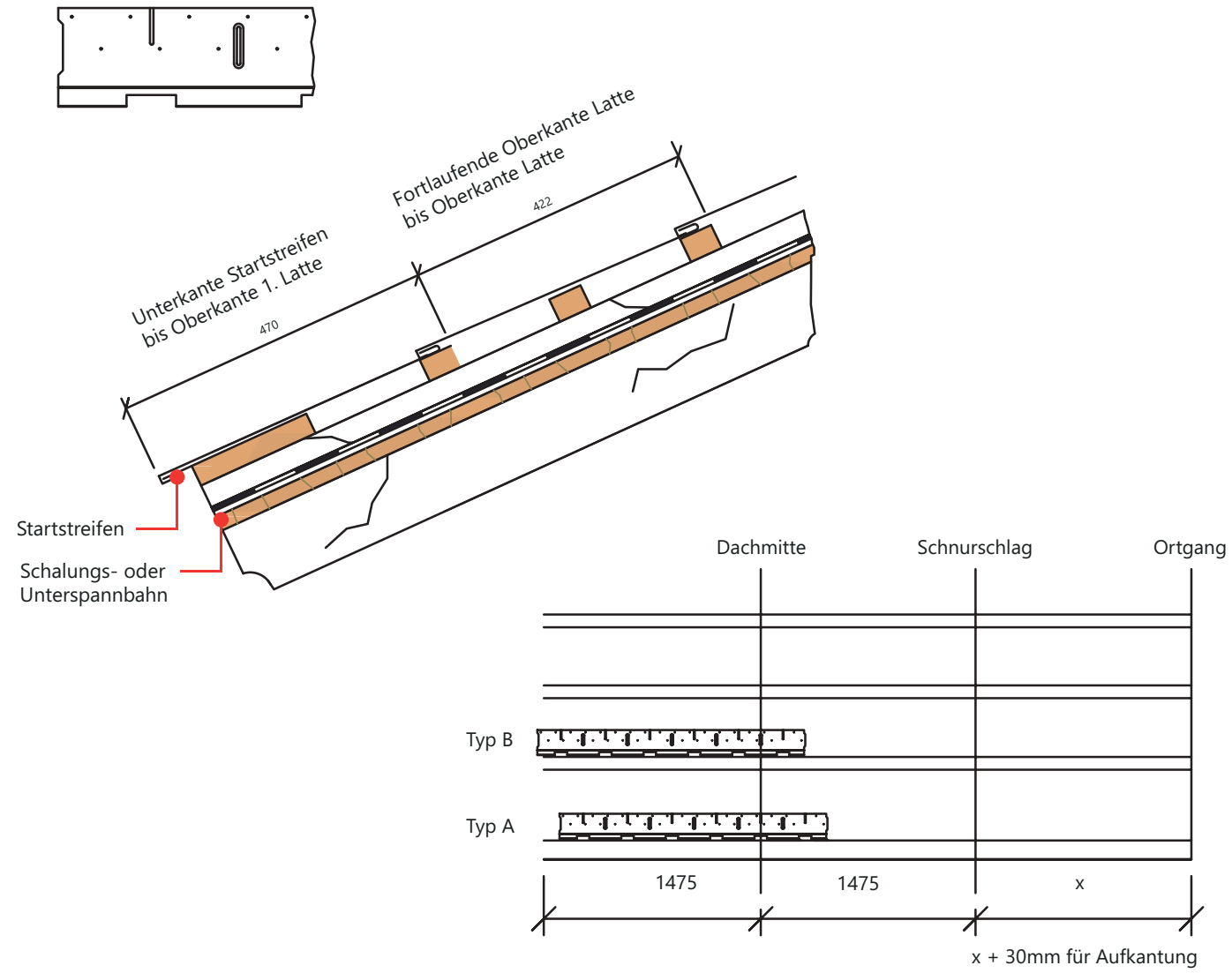

ORTGANG

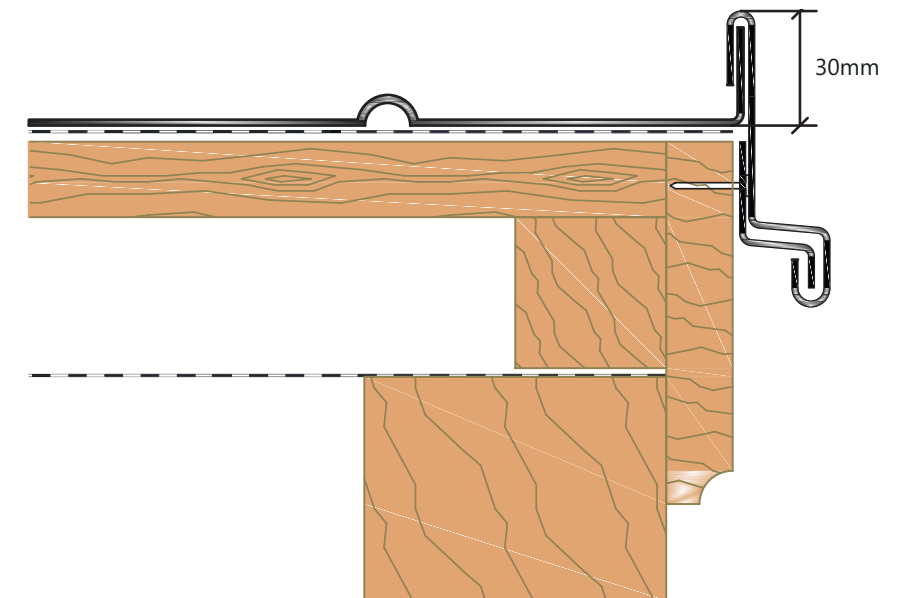
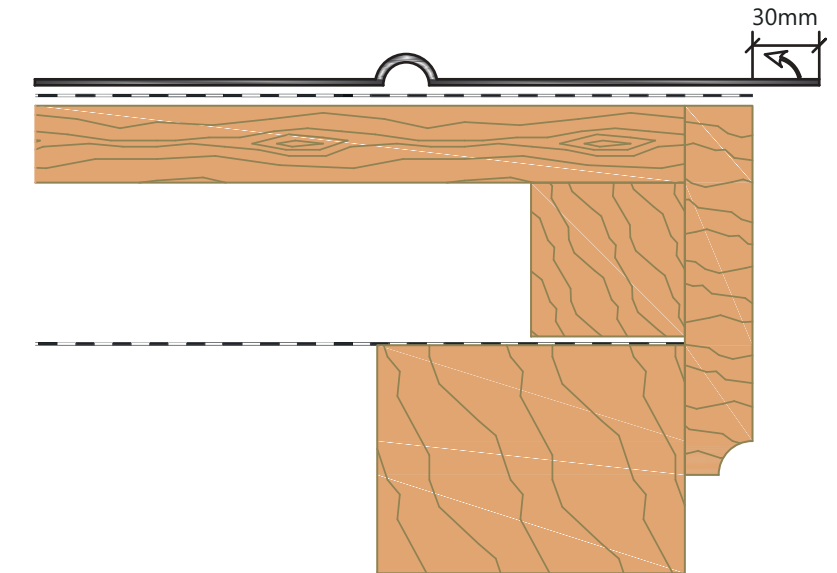



FIRST-GRAT-DETAIL

BELÜFTET MIT TURBOLÜFTER



UNBELÜFTET MIT FIRST-GRAT-REITER



DETAILANSICHT

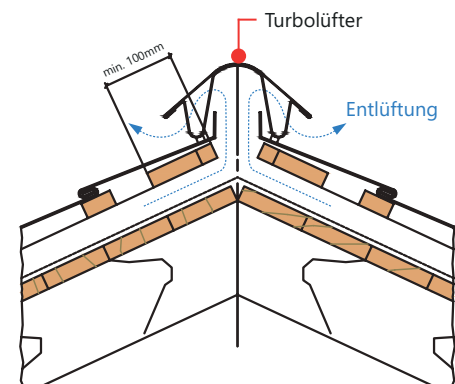

SCHNEESTOPPER

2 STK./M²









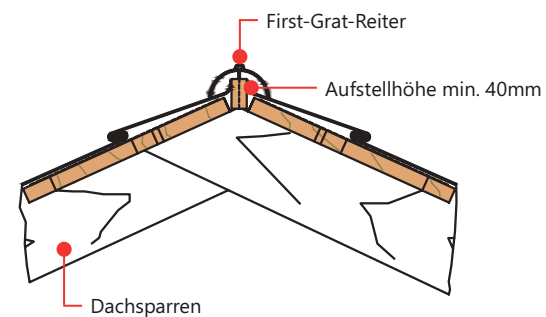

4 STK./M²











8 STK./M²



ORTGANGABSCHLUSS	SCHINDEL-TURBOLÜFTER GRUNDMODUL
2-teilig, Größe 2000 mm	für Schindelsysteme. Grundmodul belüftet, Größe 2000 mm, Lüftungsquerschnitt 208,8 cm ²
	
SCHINDEL-TURBOLÜFTER OBERTEIL	TURBOLÜFTER ENDKAPPE
für Schindelsysteme. Oberteil (Deckfläche 1930mm), Größe 2000 mm	universal (L+R)
	
FIRST-GRAT-REITER UNBELÜFTET	ENDKAPPE FIRST-GRAT-REITER
Deckfläche 950 mm, Größe 1000 mm	universal (L+R)
	
KANADA-FIRST- & GRATKAPPE	KANADA-FIRST- & GRATKAPPE SMOOTH
unbelüftet. Deckfläche 280mm. Bedarf: 3,6 Stk./m, Größe 350 mm	unbelüftet. Deckfläche 280mm, Größe 350 mm
	

LÜFTERHAUBE	STARTSTREIFEN
zum Aufnieten & Kleben	für Kanada-Schindel, Größe 2000 x 170 x 1 mm
	
ROHRDURCHFÜHRUNGSPLATTE	ENTLÜFTUNGSRÖHR
2-teilig für Schindelsysteme. Aus bandbeschichtetem Material, Größe DN 40-120	mit Abdeckkappe, Größe DN 80, 100, 120
	
KLEBESET MIT ANLEITUNG	ALU-NIETE
bestehend aus: Klebekartusche, Reiniger, Schleifschwamm, Reinigungstuch, (schwarz/grau)	mit rostfreiem Dorn, 4 x 10 mm
	
SCHNEESTOPPER	VELUX FENSTEREINFASSUNG
für Kanada-Schindel	für Schindeln und Stehfalz
	

SOLARHALTER FÜR SCHINDELSYSTEME	SCHNEEFANGSTÜTZE FÜR SCHINDELSYSTEME
horizontal, inklusive Befestigung	Doppelrohrführung
	
SCHNEEFANGROHR FÜR SCHINDELSYSTEME	LAUFROST
Stüklänge 3000 mm, inkl. Verbindungsmuffe. Größe 32 x 3 x 3000 mm	Größe 225 x 800 mm
	
LAUFROSTSTÜTZE	LAUFROSTVERBINDER VA-STAHL
	blank 2tlg. für 1 Verbindung
	
DACHSICHERHEITSHAKEN TYP B	BEFESTIGUNGSHAFT
für Schindelsysteme	für Schindelsysteme
	

SPENGLERSCHRAUBE
mit Kopflackierung & Dichtscheibe, Größe 4,5 x 45 mm